

10 zonnepanelen
 onder voorbehoud
 aantal en afmetingen in overleg
 met bouwheer en aannemer

bouwzone
 buur links
 LOT 3

VOORGEVEL LOT 4

bouwzone
 buur rechts
 LOT 5

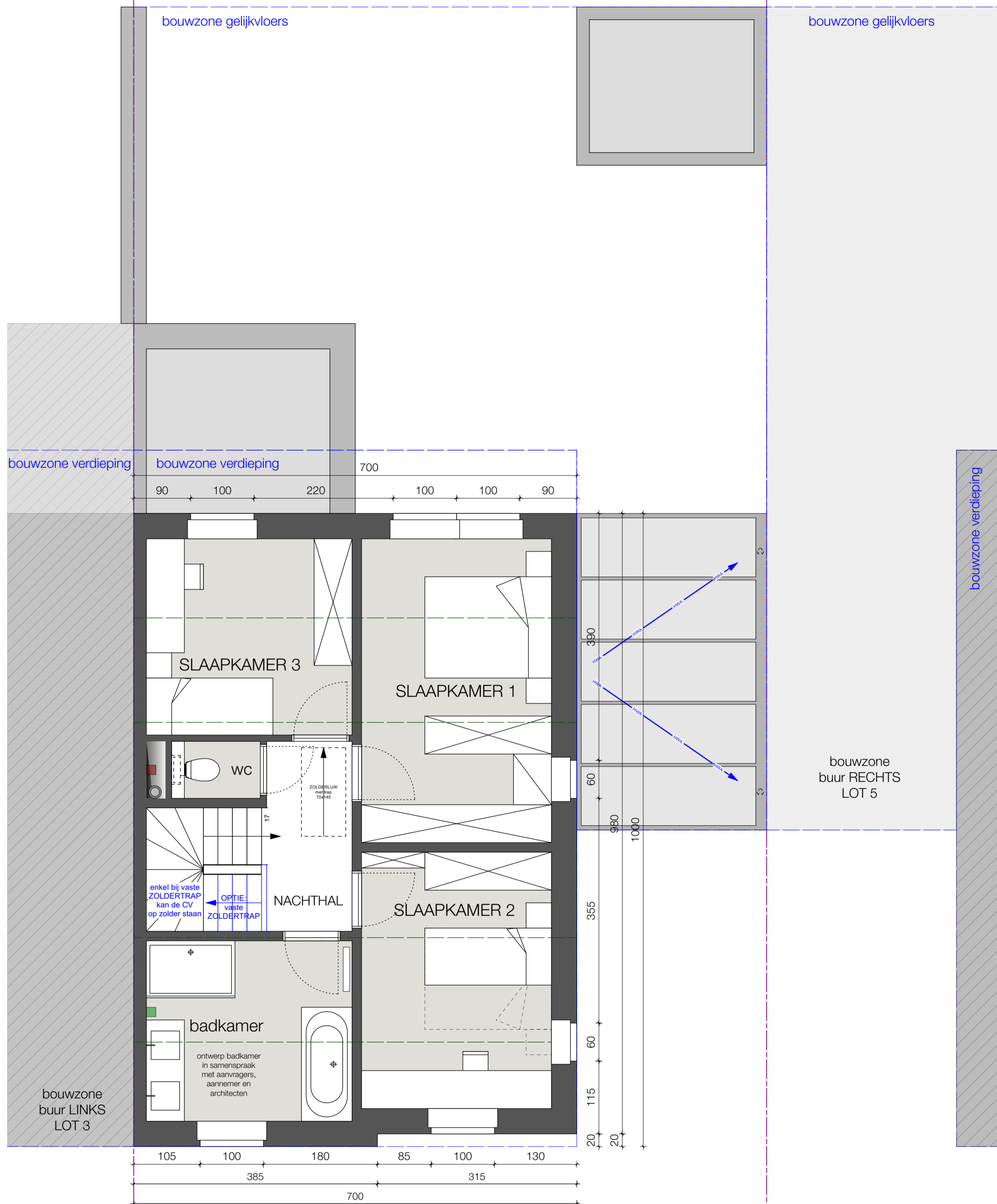

PLAN 01
LOT 4

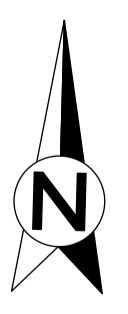

bebouwd opp. woning ±69,40m²

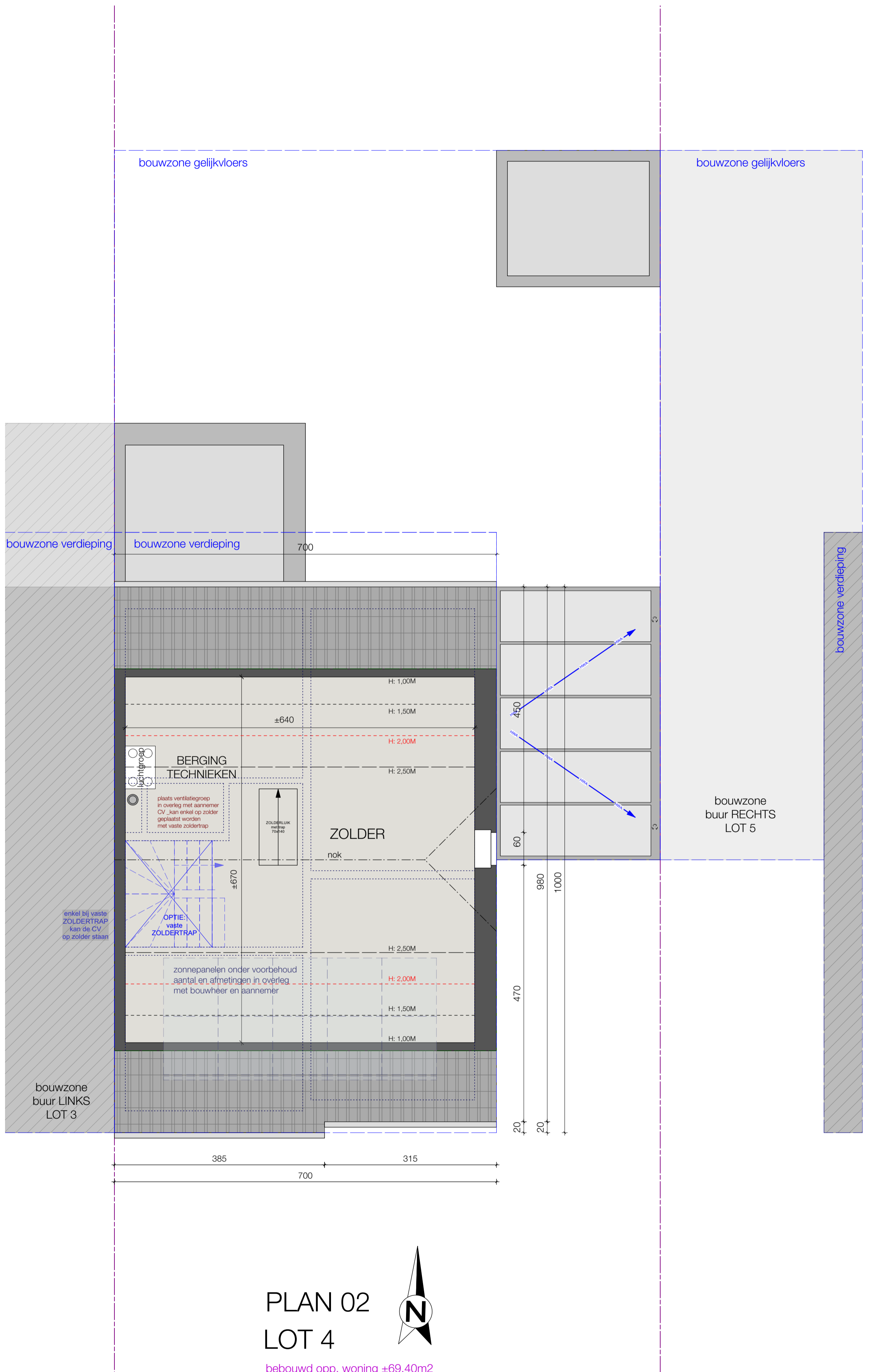

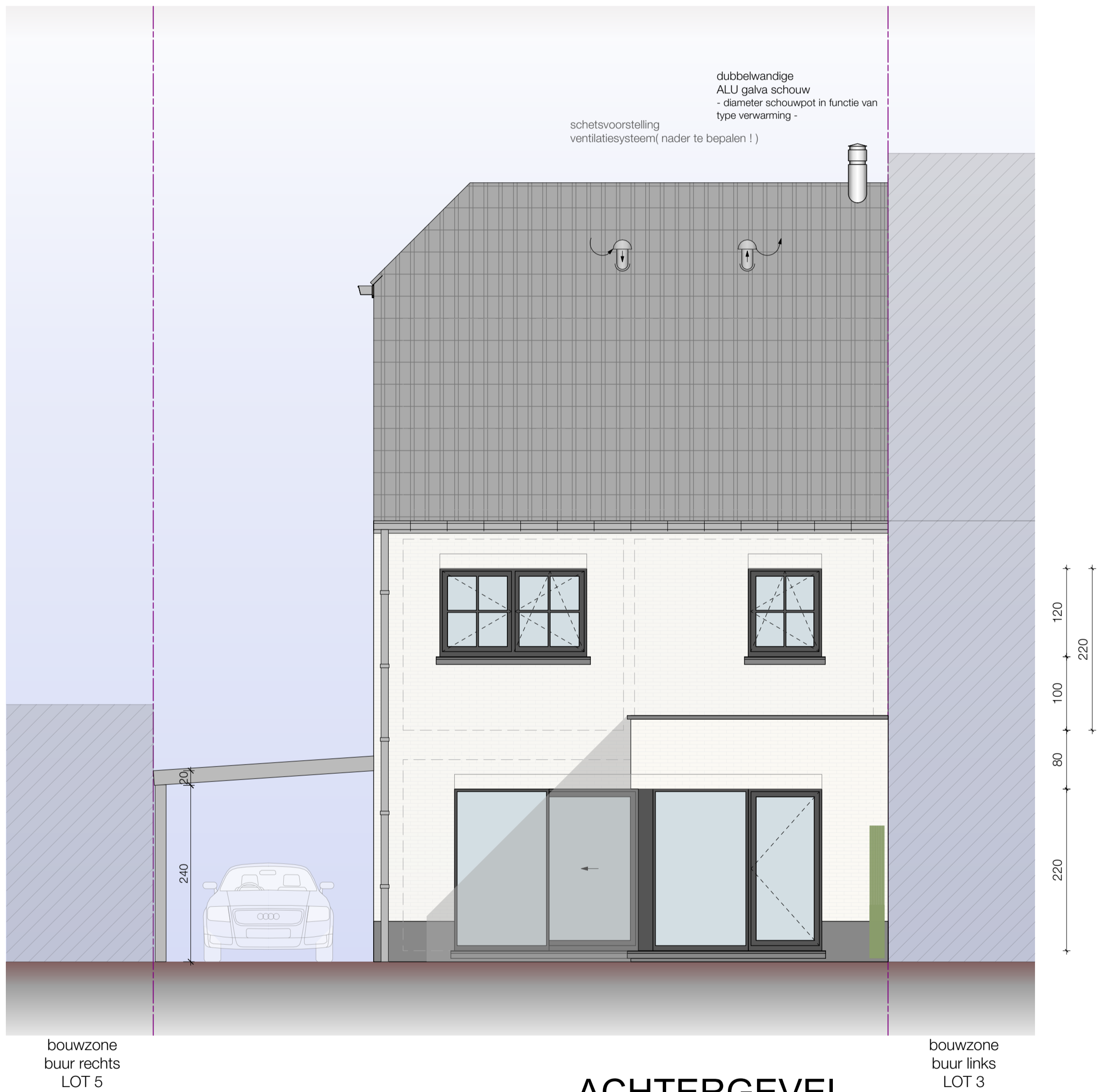

ACHTERGEVEL LOT 4

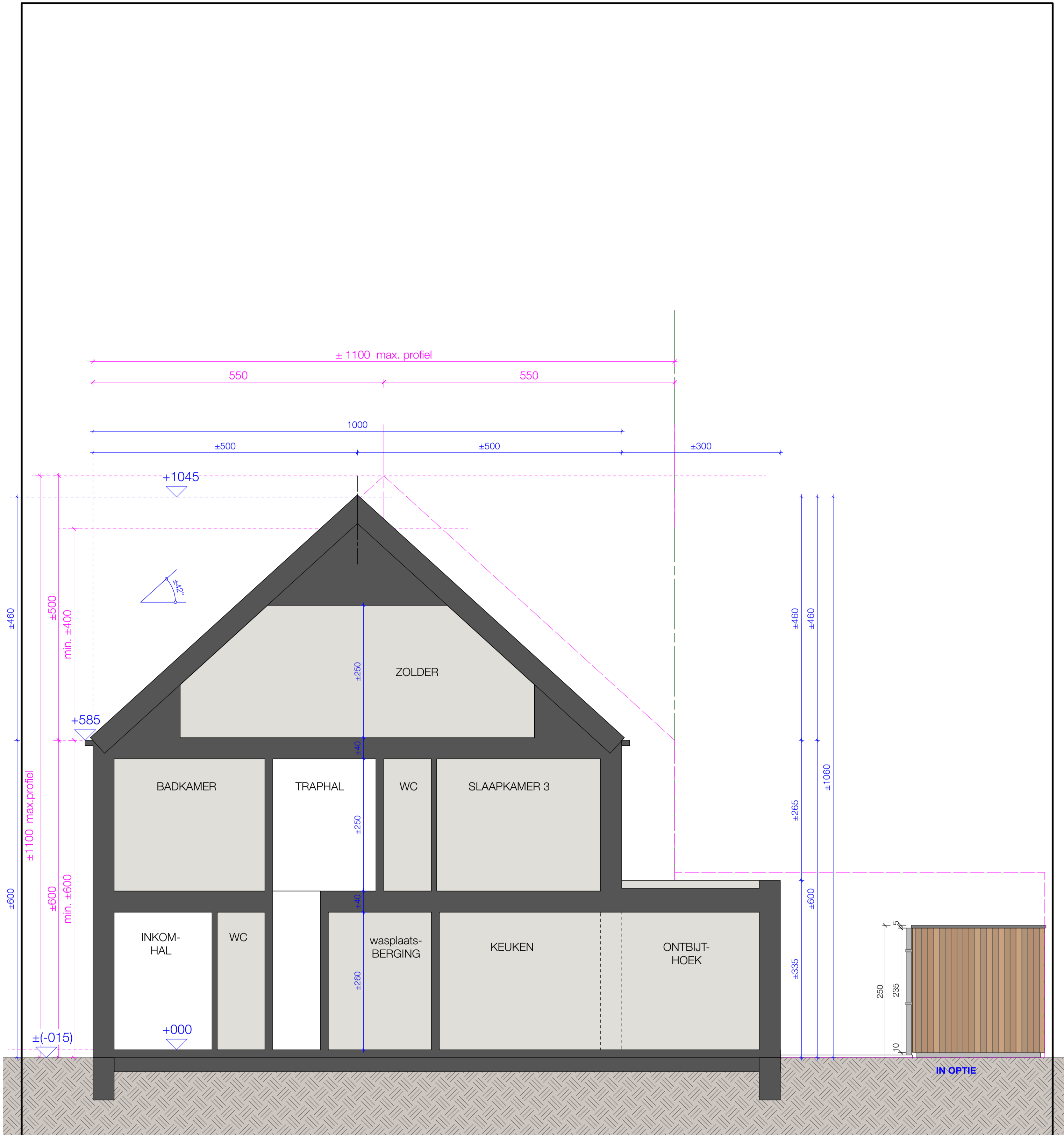

PRINCIPEDOORSNEDE

22.2266
VG-projects bvba
NIEUWSTRAAT
lot 4
9190 STEKENE

nieuwbouw eengezinswoning met carport en tuinberging dd. 30/06/2022
VG-projects bvba
NIEUWSTRAAT lot 4, 9190 STEKENE.

WE architects
Kronenhoekstraat 5,
9170 Sint-Gillis-Waas

WE-architects 
tel 03 / 707 08 18
erwin@we-architects.be
joeri@we-architects.be

IN OPTIE

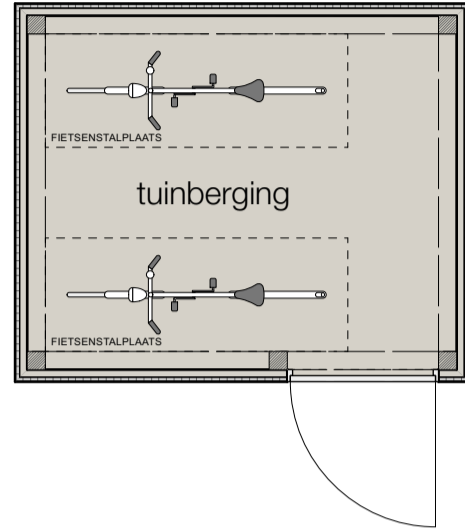

bebouwd opp. bijgebouw ±7,50m²

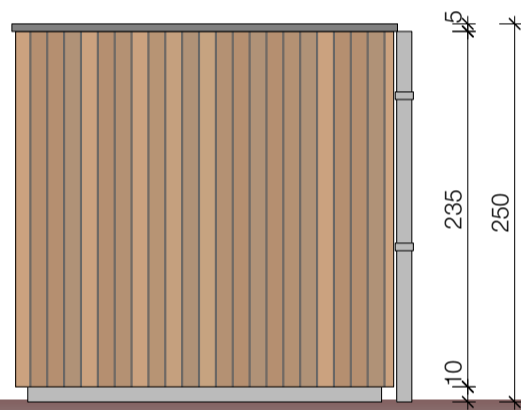

LINKS

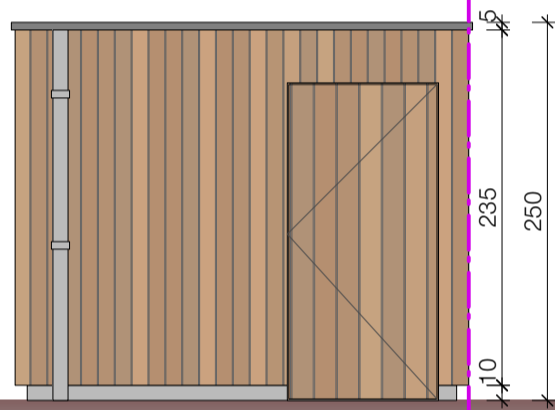

VOOR

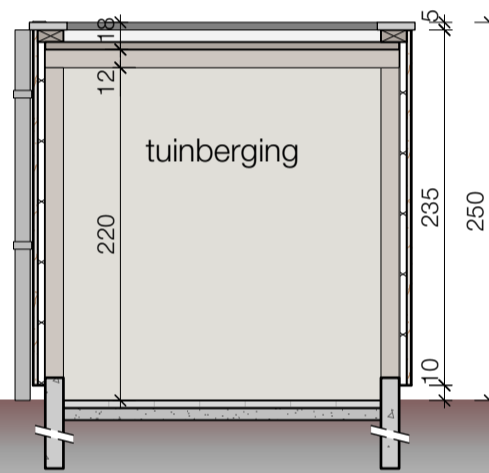

SNEDE

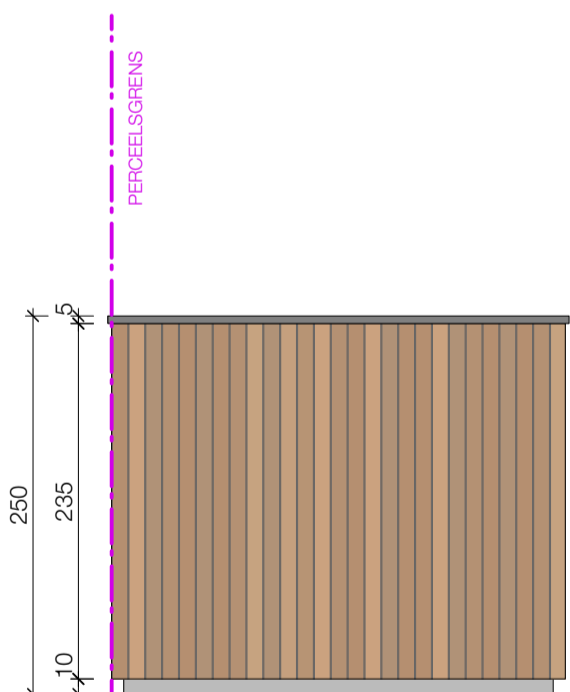

ACHTER

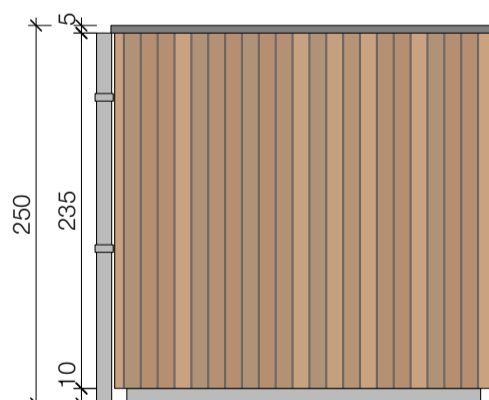

RECHTS